

E600 Receiver

User Manual



Contents

| | |
|--|----|
| Foreword | 03 |
| 01 E600 Device Composition and Description | 04 |
| 1.1 E600 Device Composition | 04 |
| 1.2 Battery Installation Instructions | 05 |
| 1.3 Extended Memory Card and SIM Card Installation | 06 |
| 1.4 Device Button and Indicator Description | 07 |
| 02 Operating Instruction | 08 |
| 2.1 Power ON-OFF | 08 |
| 2.2 Device Self-Check | 08 |
| 03 E600 Receiver WebUI Description | 09 |
| 3.1 Position Information | 10 |
| 3.2 Satellite Graph | 10 |
| 3.3 Device Information | 11 |
| 3.4 Working Mode Setting | 11 |
| 3.5 Satellite Setting | 12 |
| 3.6 System Parameter Setting | 12 |
| 3.7 NMEA Data | 13 |
| 3.8 View Logs | 13 |
| 3.9 Configuration Setting | 14 |
| 3.10 Download the Raw Data | 14 |
| 3.11 Backup Data | 15 |
| 3.12 Management | 15 |
| 04 E600 GNSS Receiver Device Components | 16 |
| 4.1 Device Charging | 16 |
| 4.2 Device External Antenna | 17 |
| 4.3 UHF High Gain Antenna | 17 |
| 4.4 External Power Cable | 17 |
| 4.5 External Radio | 17 |
| 05 Tilt Survey | 18 |
| Electronic Bubble Correction | 18 |
| Appendix A: Radio Factory Settings Frequency Table | 19 |

Foreword

Manual Introduction

Welcome to the eSurvey Series receivers manual. This manual describes how to set up and use the E Series receivers.

Disclaimer

The company is committed to continuously improving the function and performance of products, the product specifications and manual contents may be changed without prior notice, please understand! If the icons, pictures in the manual differ from the actual ones, please refer to the actual product. Before using this product, please read this instruction manual carefully. The company will not bear any responsibility for the loss caused by misoperation of this product if it is not in accordance with the requirements of the instruction manual or the failure to correctly understand the requirements of the manual.

Technology and Services

If you have any questions and/or the product documentation does not provide relevant information that you required, please contact:

Email: info@esurvey-gnss.com

Tel: +86 21 54467227

01 E600 Device Composition and Description

1.1 E600 Device Composition

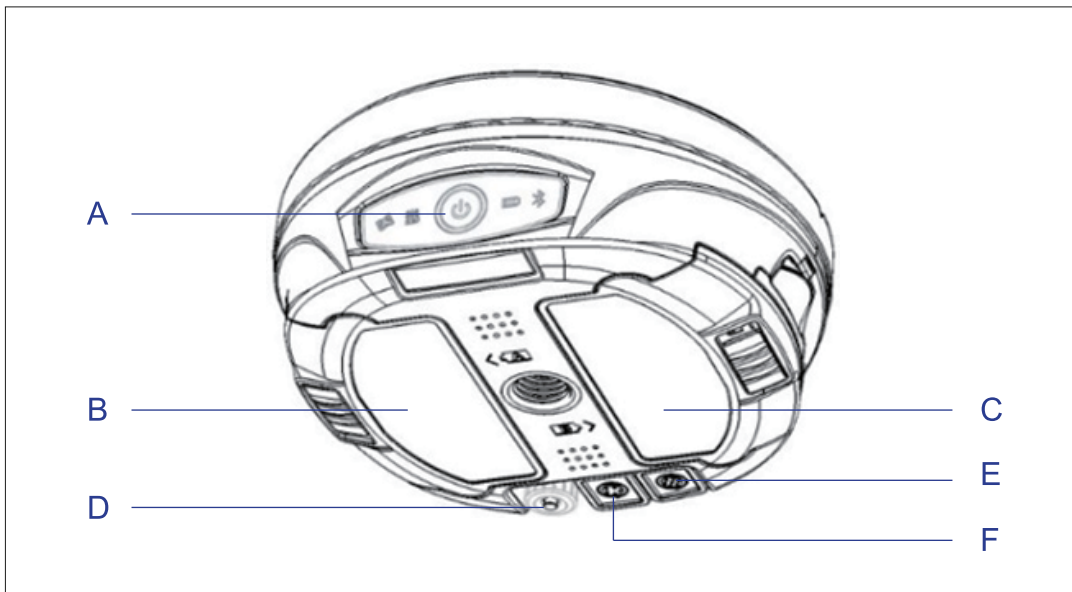

- A. Indicator light and button
- B. Battery compartment No. A
- C. Battery compartment No. B

- D. UHF Antenna interface
- E. 7 PIN (USB/Serial Port) interface
- F. 5 PIN interface

1.2 Battery Installation Instruction

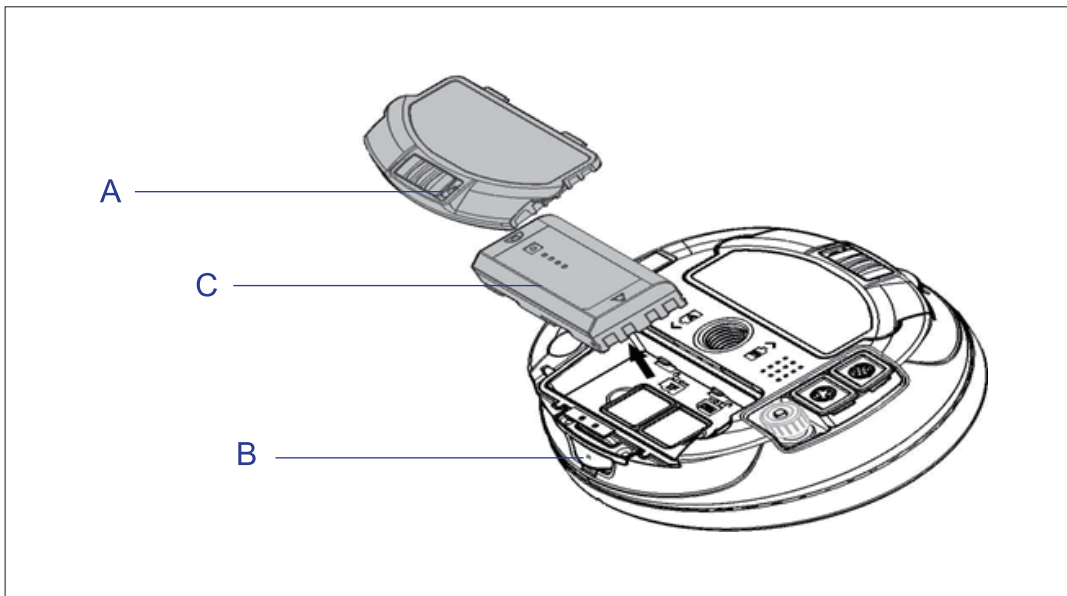

- A. Battery cover latch
- B. Battery cover open button
- C. Battery

Operation Steps

- Slide the battery cover latch to the unlocked position, press the battery cover open button, and the battery cover pops open
- Put the battery in the battery compartment, slide and lock the battery
- Close the battery cover and slide the latch to the locked position

1.3 Extended Memory Card and SIM Card Installation

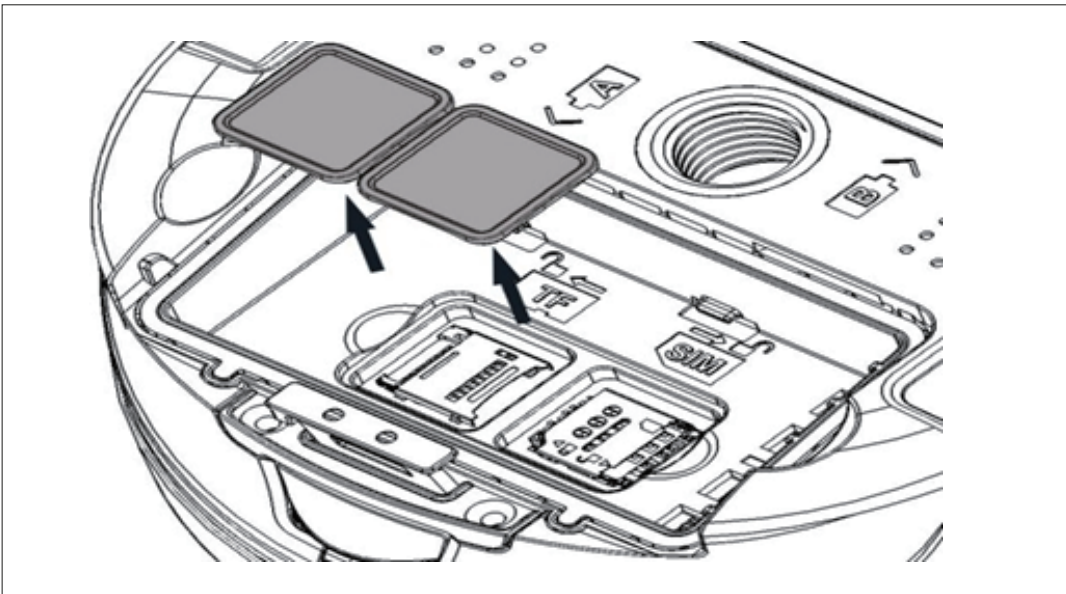

Operation Steps

- Open the cover of battery compartment No.A and remove the battery
- Open the SIM/TF card compartment cover
- Insert the SIM/TF memory card according to indicative mark and cover the protective cover

1.4 Device Button and Indicator Description

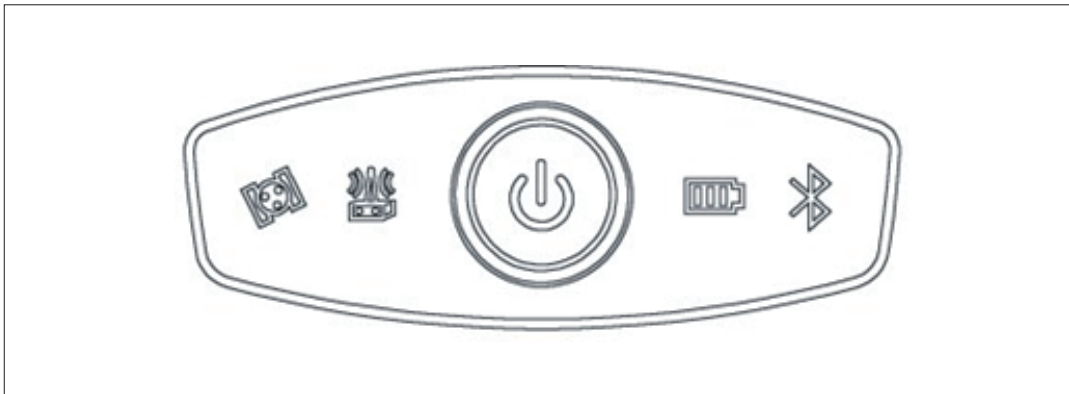

Button



Use for turning on and off the receiver

Indicator



Satellite (red-green bicolor)

Solid green light: single point positioning is successful

Flashing green light: receiving GNSS satellite

Solid red light: GNSS mainboard is abnormal



Data link (green-yellow bicolor)

Solid green light: data link setup is successful

Flashing green light: normal data transmission

Flashing yellow light: interval flashing in static mode according to the set of static sampling



Battery (green-red bicolor)

Solid green light: battery power 30%~100%

Flashing green light: battery power 10%~30%

Flashing red light: battery power < 10%



Bluetooth (blue)

Indicator light off: Bluetooth disconnected

Indicator light keeps on: Bluetooth connected

02 **Operating Instruction**

2.1 Power ON-OFF

Operation Steps

- Power on: Long press the power button, after the buzzer sounds, the device is powered on
- Power off: Long Press the power button, the device voice prompts "Power off", press the power button to confirm the device shutdown

2.2 Device Self-Check

Operation Steps

- Long press the power button, the device voice prompts "Power off", then long press the power button again until the voice prompts "Self-check"

03 E600 Receiver WebUI Description

The E600 series high-precision receiver supports the webUI to set the receiver. When the receiver is powered on, the WiFi hotspot is turned on by default, using the mobile phone or other WiFi-enabled device to find the device hotspot named by receive serial number, as shown in Figure 3-1. Connect the hotspot, open the browser and enter 192.168.10.1 in the address bar, and enter the password, as shown in Figure 3-2, 3-3. The status of the receiver can be viewed or set after submission.

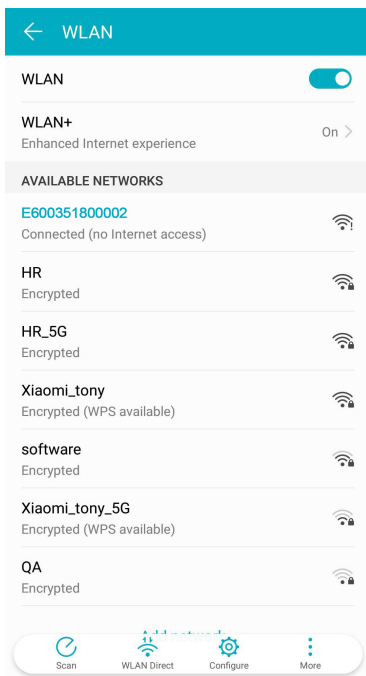

Figure 3-1

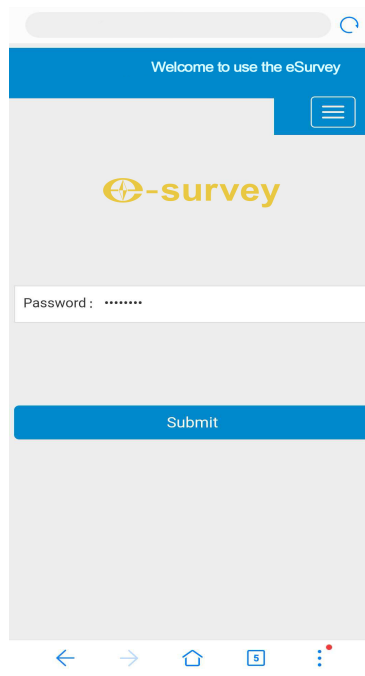

Figure 3-2

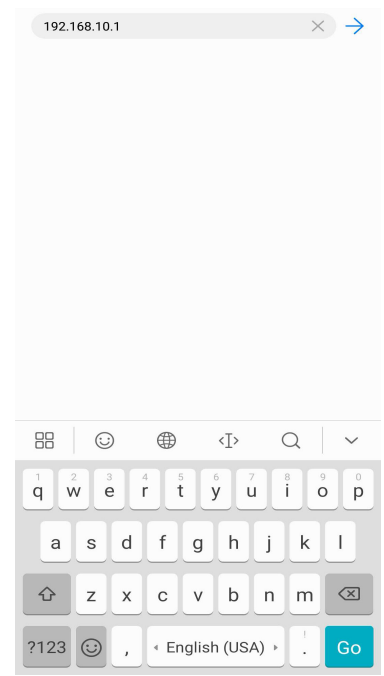

Figure 3-3

3.1 Position Information

After entering the webUI interface, you can view the device positioning status information, as shown in Figure 3-4.

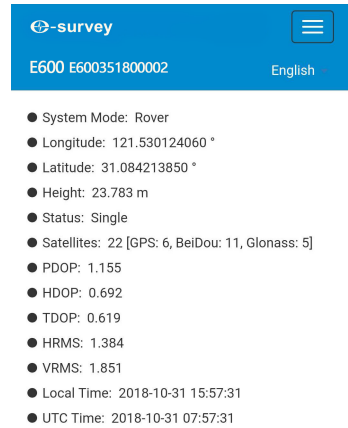

Figure 3-4

3.2 Satellite Graph

In this interface, you can set the satellite cut-off angle and view the satellite list and the detailed information of the satellite skyplot, including the position, signal to noise ratio, etc. As shown in Figure 3-5.

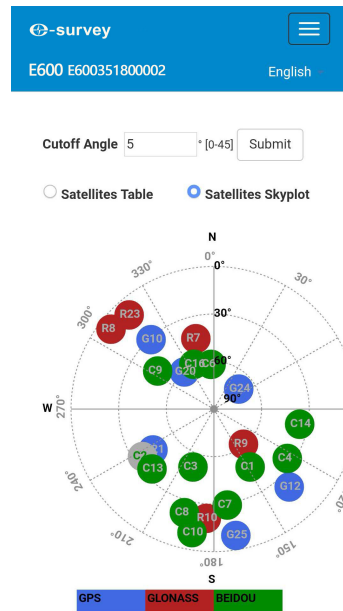

Figure 3-5

3.3 Device Information

The device information includes device model, serial number, firmware version, battery power, data storage, etc.

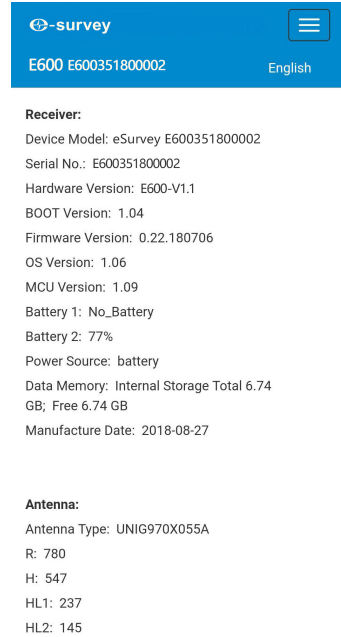

Figure 3-6

3.4 Working Mode Setting

The working mode includes the base station, rover station, static setting, and data link setting. The setting method is basically the same as the eSurvey software.

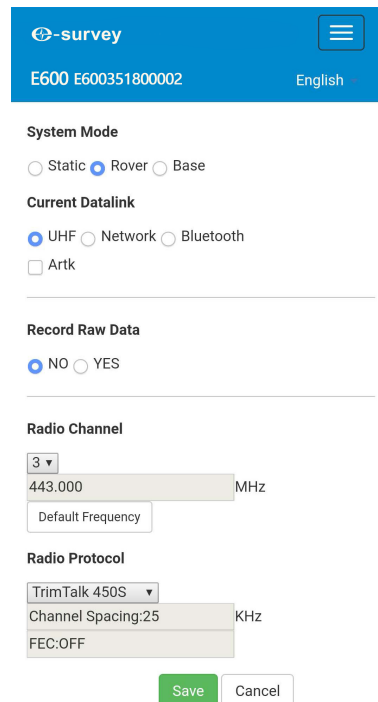

Figure 3-7

3.5 Satellite Setting

This interface can set the satellite altitude cut-off angle and can open the supported satellite systems: GPS, GLONASS, Beidou, GALILEO, SBAS. RTK timeout can also be set in this interface.

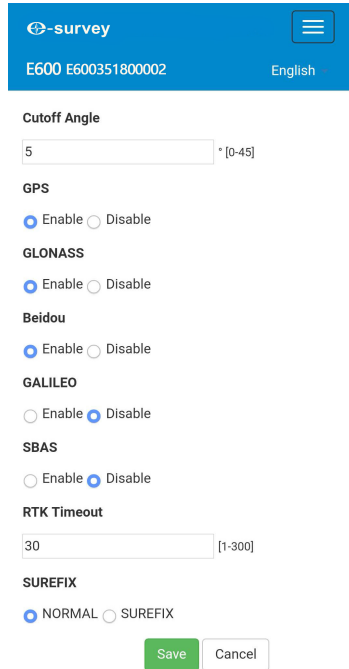

Figure 3-8

3.6 System Parameter Setting

You can set time zone, direct link mode, sensor, 7-pin serial port baud rate, speaker, first storage location, device debug, tracker, remote debug and WIFI hotspot share network. As shown in Figure 3-9, 3-10.

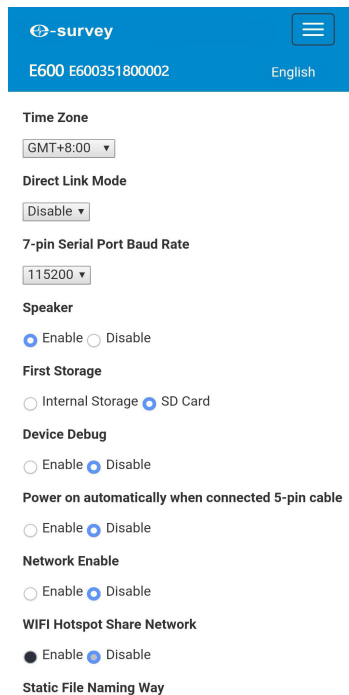

Figure 3-9

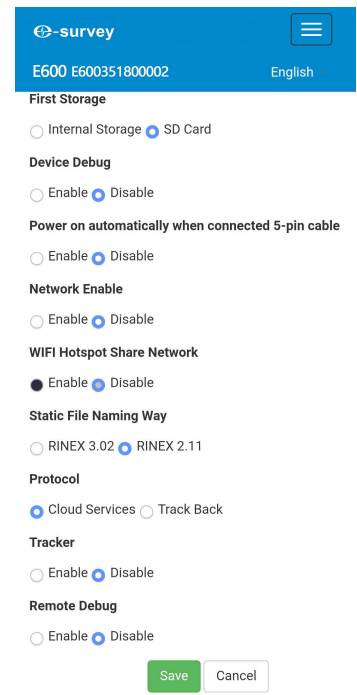

Figure 3-10

3.7 NMEA Data

You can set and select the outputted NMEA data content.

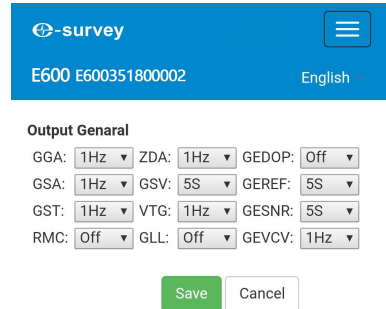

Figure 3-11

3.8 View Logs

APP log and system log.

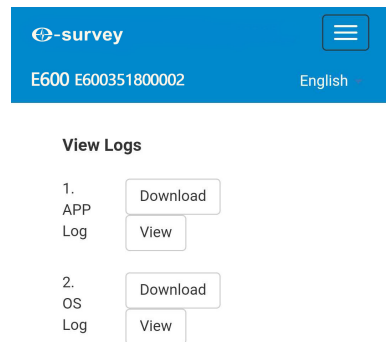

Figure 3-12

3.9 Configuration Setting

If the handheld stores a configuration set, you can directly call the configuration set files and save the current configuration set

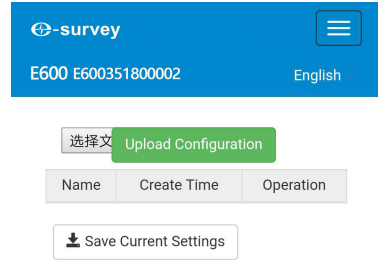

Figure 3-13

3.10 Download the Raw Data

The raw data of this interface is the static measurement data or the data saved when the original recording is selected during RTK measurement, as shown in Figure 3-14. In addition to downloading and deleting original data in the webUI, the E600 receiver also supports direct editing and conversion of 'dat' raw data. When editing, you can edit the point name and antenna height. As shown in Figure 3-15, when converting, it can be converted to Rinex2.10 or Rinex3.02 format, as shown in Figure 3-16.

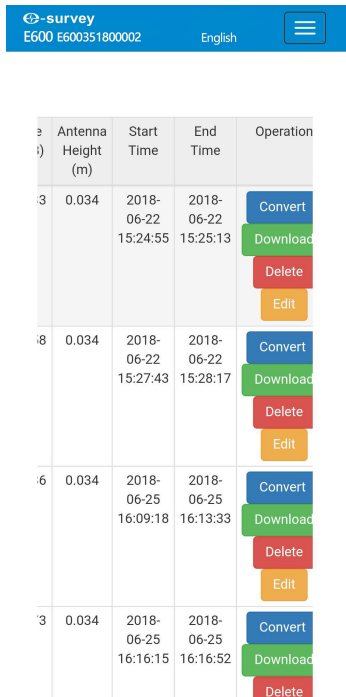

Figure 3-14

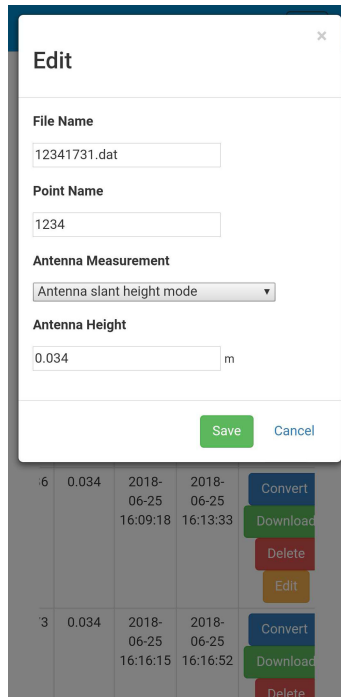

Figure 3-15

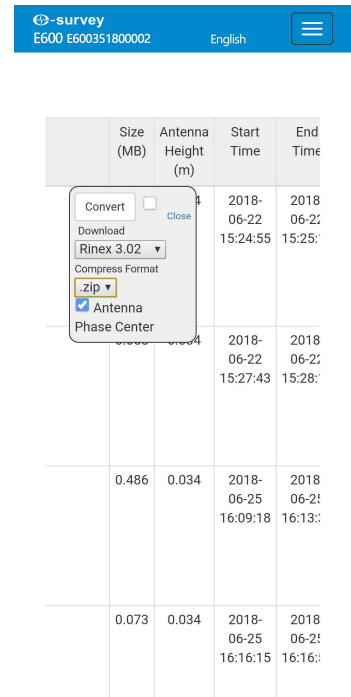

Figure 3-16

3.11 Backup Data

The E series receivers have dual backup function of RTK measurement data. Besides stored in handheld, RTK measurement data can also automatically store in the internal storage of receiver. The E series receivers can use 7-pin cable to connect to the host computer to obtain RTK data, it can also download RTK data in the webUI interface.

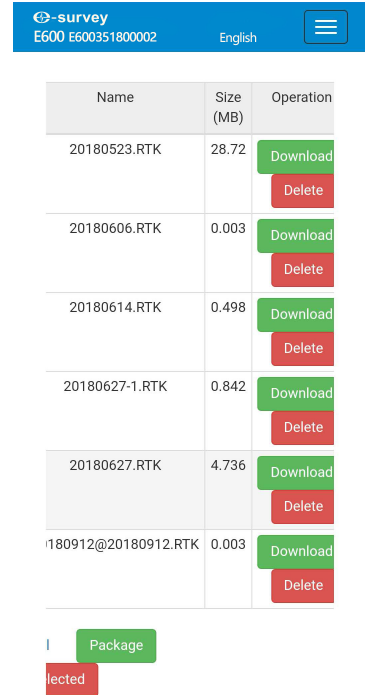

Figure 3-17

3.12 Management

In this interface, you can upgrade the mainboard firmware, register the device registration code, and register the GNSS registration code (board function authorization registration). It also can enable security authentication, mainly to set a password when logging and device WiFi connection. This interface can also perform some operations directly on the device system, including formatting the disk, self-checking, restoring factory settings, and restarting the device.

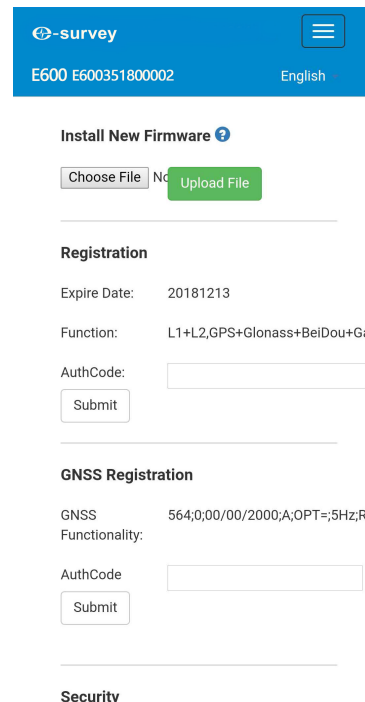

Figure 3-18

04 E600 GNSS Receiver Device Components

4.1 Device Charging

The E600 receiver is equipped with two lithium-ion batteries. The user can charge the battery with the standard charger. The battery is in charge when the charging indicator is red, and the battery is completely charged when the charging indicator is green. The front of the battery is equipped with a power detection button and 4 LED power indicator lights, the user can judge the battery power according to the number of lights.



Figure 4-1 charging panel



Figure 4-2 Charging Plug



Figure 4-3 Battery

4.2 Device External Antenna

The E600 receiver uses 2.15dBi's omnidirectional internal radio antenna with the function of transmitting and receiving. The antenna is lightweight and wear-resistant, making it ideal for field measurements. The frequency range of built-in radio antenna is 410-470MHz.



Figure 4-4 Built-in radio antenna

4.4 External Power Cable

This cable can be used to connect an external power supply (red and black clips) to power the receiver (small 5-pin LEMO head) and external radio (large 5-pin LEMO head).



Figure 4-6 External power cable

4.3 UHF High Gain Antenna

The UHF high-gain antenna has a gain of 5dBi and can be used with an external radio to achieve a longer working distance.



Figure 4-5 UHF High gain antenna

4.5 External Radio

The Radio is an only transmitting, high-power radio, which can be configured for connection via special configuration software. The detailed introduction and operation methods, please refer to the relevant document or video.



Figure 4-7 External Radio

05 Tilt Survey

Electronic Bubble Correction

Correction method: Place the device on the ranging pole, and stabilize the ranging pole to center the electronic bubble. In the eSurvey software, first open the electronic bubble in the device setting, then calibrate in calibrate sensor > E-Bubble.

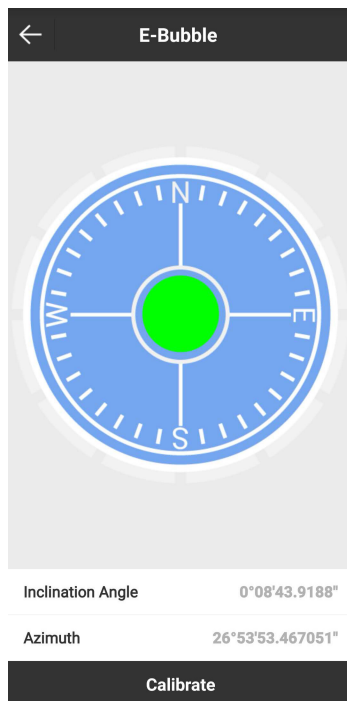

FIGURE 5-1

**Appendix A:
Radio Factory Settings Frequency Table**

| Channels \ Frequency | MHZ |
|----------------------|-----|
| Channel 1 | 441 |
| Channel 2 | 442 |
| Channel 3 | 443 |
| Channel 4 | 444 |
| Channel 5 | 445 |
| Channel 6 | 446 |
| Channel 7 | 447 |
| Channel 8 | 448 |